



Power contactor, AC-3 95 A, 45 kW / 400 V 230 V AC, 50 Hz 3-pole, Size S3 Screw terminal !!! Phased-out product !!! Successor is SIRIUS 3RT2 Preferred successor type is >>3RT2046-1AP00<<

product brand name	SIRIUS
product designation	power contactor
General technical data	
size of contactor	S3
insulation voltage rated value	1 000 V
degree of pollution	3
surge voltage resistance rated value	6 kV
maximum permissible voltage for safe isolation between coil and main contacts acc. to EN 60947-1	690 V
protection class IP <ul style="list-style-type: none"> • on the front • of the terminal 	IP20; IP20 on the front with cover / box terminal IP00
shock resistance at rectangular impulse <ul style="list-style-type: none"> • at AC 	6.8g / 5 ms, 4g / 10 ms
shock resistance with sine pulse <ul style="list-style-type: none"> • at AC 	10.6g / 5 ms, 6.2g / 10 ms
mechanical service life (switching cycles) <ul style="list-style-type: none"> • of contactor typical • of the contactor with added electronically optimized auxiliary switch block typical • of the contactor with added auxiliary switch block typical 	10 000 000 5 000 000 10 000 000
reference code acc. to IEC 81346-2	Q
Substance Prohibitance (Date)	01.05.2012 00:00:00
Ambient conditions	
installation altitude at height above sea level maximum	2 000 m
ambient temperature <ul style="list-style-type: none"> • during operation • during storage 	-25 ... +60 °C -55 ... +80 °C
Main circuit	
number of poles for main current circuit	3
number of NO contacts for main contacts	3
number of NC contacts for main contacts	0
operational current <ul style="list-style-type: none"> • at AC-1 at 400 V at ambient temperature 40 °C rated value • at AC-1 <ul style="list-style-type: none"> — up to 690 V at ambient temperature 40 °C rated value 	120 A 120 A





— up to 690 V at ambient temperature 60 °C rated value	100 A
— up to 1000 V at ambient temperature 40 °C rated value	70 A
— up to 1000 V at ambient temperature 60 °C rated value	60 A
● at AC-3	
— at 400 V rated value	95 A
— at 690 V rated value	58 A
— at 1000 V rated value	30 A
● at AC-4 at 400 V rated value	80 A
connectable conductor cross-section in main circuit at AC-1	
● at 60 °C minimum permissible	35 mm ²
● at 40 °C minimum permissible	50 mm ²
operational current for approx. 200000 operating cycles at AC-4	
● at 400 V rated value	42 A
● at 690 V rated value	27 A
operational current	
● at 1 current path at DC-1	
— at 24 V rated value	100 A
— at 110 V rated value	9 A
● with 2 current paths in series at DC-1	
— at 24 V rated value	100 A
— at 110 V rated value	100 A
● with 3 current paths in series at DC-1	
— at 24 V rated value	100 A
— at 110 V rated value	100 A
operational current	
● at 1 current path at DC-3 at DC-5	
— at 24 V rated value	40 A
— at 110 V rated value	2.5 A
● with 2 current paths in series at DC-3 at DC-5	
— at 24 V rated value	100 A
— at 110 V rated value	100 A
● with 3 current paths in series at DC-3 at DC-5	
— at 24 V rated value	100 A
— at 110 V rated value	100 A
operating power	
● at AC-1	
— at 230 V at 60 °C rated value	38 kW
— at 400 V rated value	66 kW
— at 690 V rated value	114 kW
— at 690 V at 60 °C rated value	114 kW
— at 1000 V at 60 °C rated value	98 W
● at AC-2 at 400 V rated value	45 kW
● at AC-3	
— at 230 V rated value	22 kW
— at 400 V rated value	45 kW
— at 500 V rated value	55 kW
— at 690 V rated value	55 kW
— at 1000 V rated value	37 W
operating power for approx. 200000 operating cycles at AC-4	
● at 400 V rated value	22 kW
● at 690 V rated value	25.4 kW
thermal short-time current limited to 10 s	760 A
no-load switching frequency	
● at AC	5 000 1/h

operating frequency	
<ul style="list-style-type: none"> • at AC-1 maximum • at AC-2 maximum • at AC-3 maximum • at AC-4 maximum 	900 1/h 350 1/h 850 1/h 250 1/h
Control circuit/ Control	
type of voltage of the control supply voltage	AC
control supply voltage at AC	
<ul style="list-style-type: none"> • at 50 Hz rated value 	230 V
control supply voltage frequency	
<ul style="list-style-type: none"> • 1 rated value 	50 Hz
operating range factor control supply voltage rated value of magnet coil at AC	
<ul style="list-style-type: none"> • at 50 Hz 	0.8 ... 1.1
apparent pick-up power of magnet coil at AC	270 V·A
inductive power factor with closing power of the coil	0.68
apparent holding power of magnet coil at AC	22 V·A
inductive power factor with the holding power of the coil	0.27
closing delay	
<ul style="list-style-type: none"> • at AC 	17 ... 90 ms
opening delay	
<ul style="list-style-type: none"> • at AC 	10 ... 25 ms
arcing time	10 ... 15 ms
Auxiliary circuit	
number of NC contacts for auxiliary contacts instantaneous contact	0
number of NO contacts for auxiliary contacts instantaneous contact	0
operational current at AC-12 maximum	10 A
operational current at AC-15	
<ul style="list-style-type: none"> • at 230 V rated value • at 400 V rated value 	6 A 3 A
operational current at DC-12	
<ul style="list-style-type: none"> • at 60 V rated value • at 110 V rated value • at 220 V rated value 	6 A 3 A 1 A
operational current at DC-13	
<ul style="list-style-type: none"> • at 24 V rated value • at 60 V rated value • at 110 V rated value • at 220 V rated value 	10 A 2 A 1 A 0.3 A
contact reliability of auxiliary contacts	1 faulty switching per 100 million (17 V, 1 mA)
UL/CSA ratings	
contact rating of auxiliary contacts according to UL	A600 / Q600
Short-circuit protection	
design of the fuse link	
<ul style="list-style-type: none"> • for short-circuit protection of the main circuit <ul style="list-style-type: none"> — with type of coordination 1 required — with type of assignment 2 required • for short-circuit protection of the auxiliary switch required 	fuse gL/gG: 250 A fuse gL/gG: 160 A fuse gL/gG: 10 A
Installation/ mounting/ dimensions	
fastening method	screw and snap-on mounting onto 35 mm and 75 mm standard mounting rail
<ul style="list-style-type: none"> • side-by-side mounting 	Yes
height	146 mm
width	70 mm
depth	139 mm

required spacing for grounded parts at the side	6 mm
Connections/ Terminals	
type of electrical connection <ul style="list-style-type: none"> • for main current circuit • for auxiliary and control circuit 	screw-type terminals screw-type terminals
type of connectable conductor cross-sections <ul style="list-style-type: none"> • for main contacts <ul style="list-style-type: none"> — solid — stranded — solid or stranded — finely stranded with core end processing — finely stranded without core end processing • at AWG cables for main contacts 	2x (2.5 ... 16 mm ²) 2x (10 ... 50 mm ²) 2x (2,5 ... 16 mm ²) 2x (2.5 ... 35 mm ²) 2x (10 ... 35 mm ²) 2x (10 ... 1/0)
type of connectable conductor cross-sections <ul style="list-style-type: none"> • for auxiliary contacts <ul style="list-style-type: none"> — solid — finely stranded with core end processing • at AWG cables for auxiliary contacts 	2x (0.5 ... 1.5 mm ²), 2x (0.75 ... 2.5 mm ²), max. 2x (0.75 ... 4 mm ²) 2x (0.5 ... 1.5 mm ²), 2x (0.75 ... 2.5 mm ²) 2x (20 ... 16), 2x (18 ... 14), 1x 12

Certificates/ approvals

General Product Approval	EMC	Declaration of Conformity
    		Miscellaneous

Declaration of Conformity	Test Certificates	Marine / Shipping			
	Type Test Certificates/Test Report	Special Test Certificate			

Marine / Shipping	other	Railway			
	Miscellaneous	Confirmation	Confirmation	Miscellaneous	Special Test Certificate

Further information

Information- and Downloadcenter (Catalogs, Brochures,...)
<https://www.siemens.com/ic10>

Industry Mall (Online ordering system)
<https://mall.industry.siemens.com/mall/en/en/Catalog/product?mlfb=3RT1046-1AP00>

Cax online generator
<http://support.automation.siemens.com/WW/CAXorder/default.aspx?lang=en&mlfb=3RT1046-1AP00>

Service&Support (Manuals, Certificates, Characteristics, FAQs,...)
<https://support.industry.siemens.com/cs/ww/en/ps/3RT1046-1AP00>

Image database (product images, 2D dimension drawings, 3D models, device circuit diagrams, EPLAN macros, ...)
http://www.automation.siemens.com/bilddb/cax_de.aspx?mlfb=3RT1046-1AP00&lang=en

Characteristic: Tripping characteristics, I^t, Let-through current
<https://support.industry.siemens.com/cs/ww/en/ps/3RT1046-1AP00/char>

Further characteristics (e.g. electrical endurance, switching frequency)
<http://www.automation.siemens.com/bilddb/index.aspx?view=Search&mlfb=3RT1046-1AP00&objecttype=14&gridview=view1>

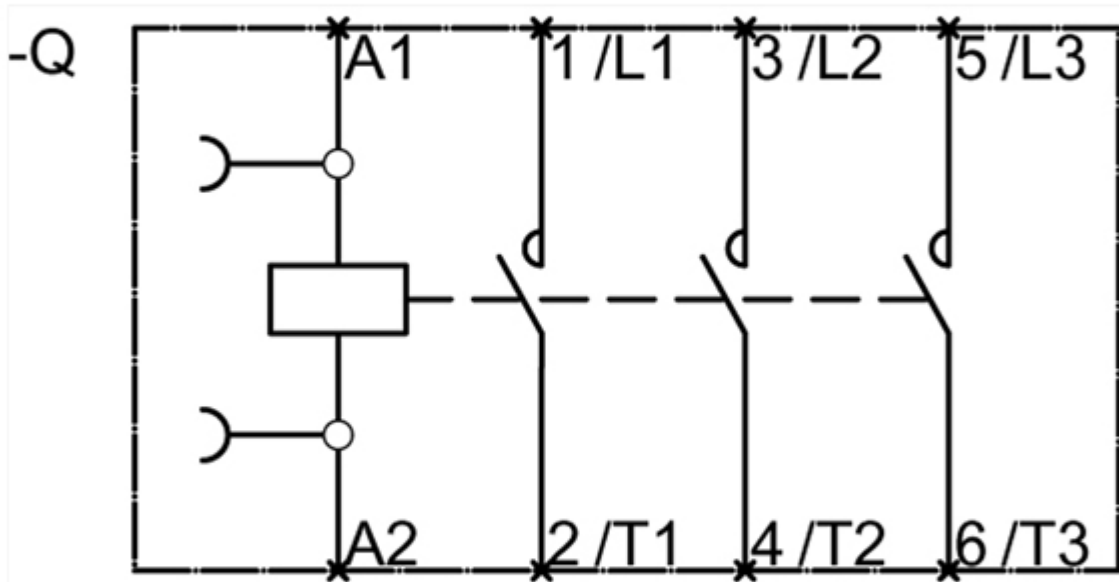
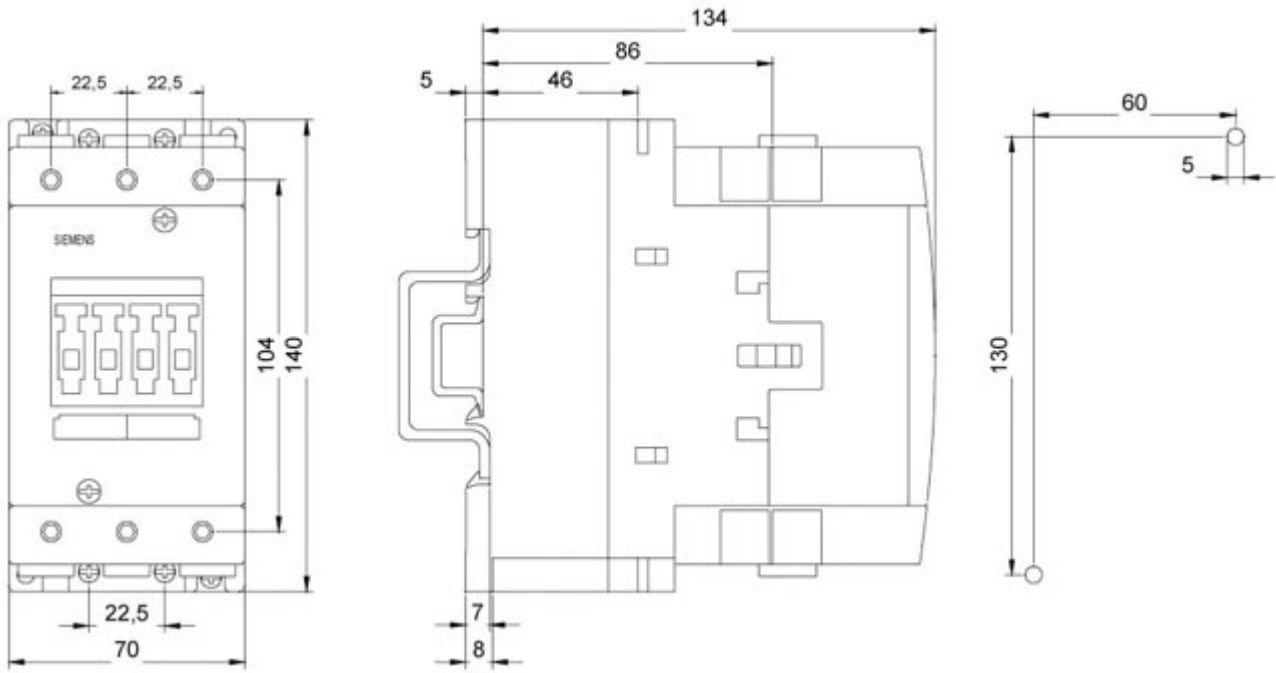

last modified:

1/18/2021 